



ACCESSORIES FOR

SLIDE & FOLD DOOR

- Sliding Door
- Folding Door



THE MODERN ACCESSORIES
SLIDE & FOLD DOOR

Rangkaian aksesoris pintu dorong lipat berkualitas dari Dekkson yang terbukti dapat membantu memastikan pintu dorong lipat anda berfungsi secara optimal, sekaligus menjamin tingkat keamanan dan daya tahan yang tinggi. Selain itu, Dekkson juga menawarkan tipe aksesoris pintu dorong lipat yang beragam, sehingga anda dapat mewujudkan apapun jenis pintu dorong lipat yang anda idamkan.

Table of Contents :

ACCESSORIES FOR SLIDE & FOLD DOOR CONTENT (80 Kg)

Pintu dorong lipat eksterior roda "STANDARD" **03**

- Skema Pintu Dorong
- Gambar Tampak, Gambar Potongan, dan Gambar Denah

Pintu dorong lipat eksterior roda "L" **05**

- Skema Pintu Dorong
- Gambar Tampak, Gambar Potongan, dan Gambar Denah

Pintu dorong menikung eksterior roda "STANDARD" **07**

- Skema Pintu Dorong
- Gambar Tampak, Gambar Potongan, dan Gambar Denah

Pintu dorong lipat tengah interior **09**

- Skema Pintu Dorong
- Gambar Tampak, Gambar Potongan, dan Gambar Denah

Pintu dorong lipat pinggir interior **11**

- Skema Pintu Dorong
- Gambar Tampak, Gambar Potongan, dan Gambar Denah

Indeks aksesories pintu dorong lipat **13**

- Skema Pintu Dorong
- Gambar Tampak, Gambar Potongan, dan Gambar Denah

PINTU DORONG LIPAT EKSTERIOR

RODA "STANDARD"



① RODA ATAS TENGAH



WH 9105 (57MM)
GALV

② RODA ATAS PINGGIR



WH 9106 (57MM)
GALV

③ ENGSEL TENGAH



HN 8306 (57MM)
GALV

④ RODA BAWAH TENGAH



WH 8205 (57MM)
GALV

⑤ RODA BAWAH PINGGIR



WH 8206 (57MM)
GALV

⑥ ENGSEL KUPU - KUPU



ESS EL 4X3X3MM 2BB SSS

⑦ GREDEL TANAM PLAT



FBP 8" SSS

⑧ GREDEL BAWAH BIASA



BB 9204 (38/57MM)
GALV

⑨ REL ATAS



TR 9123 - 2.3M (57MM) GALV
TR 9129 - 2.9M (57MM) GALV

⑩ REL BAWAH



TR 9224 - 2.4M (38/57MM) GALV
TR 9230 - 3M (38/57MM) GALV

⑪ BREKET SAMPING



BR 9100 (57MM)
GALV

⑫ PULL HANDLE



PH D855 19x195x152 SSS

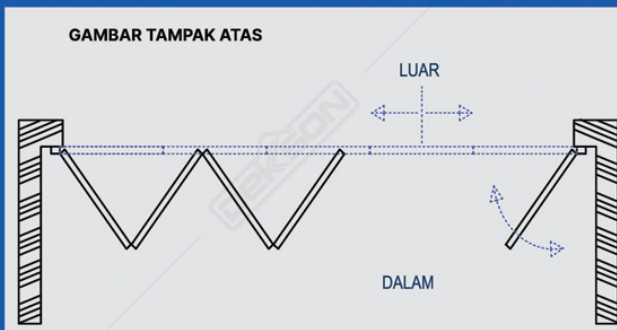
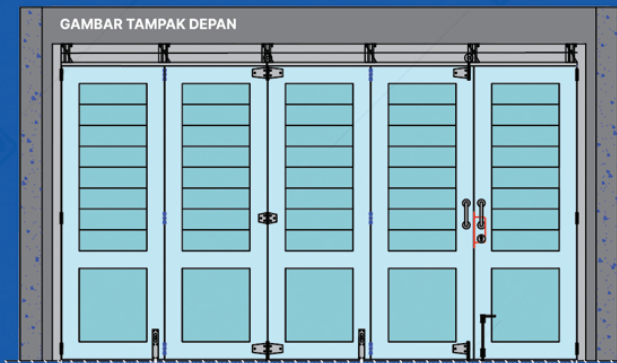
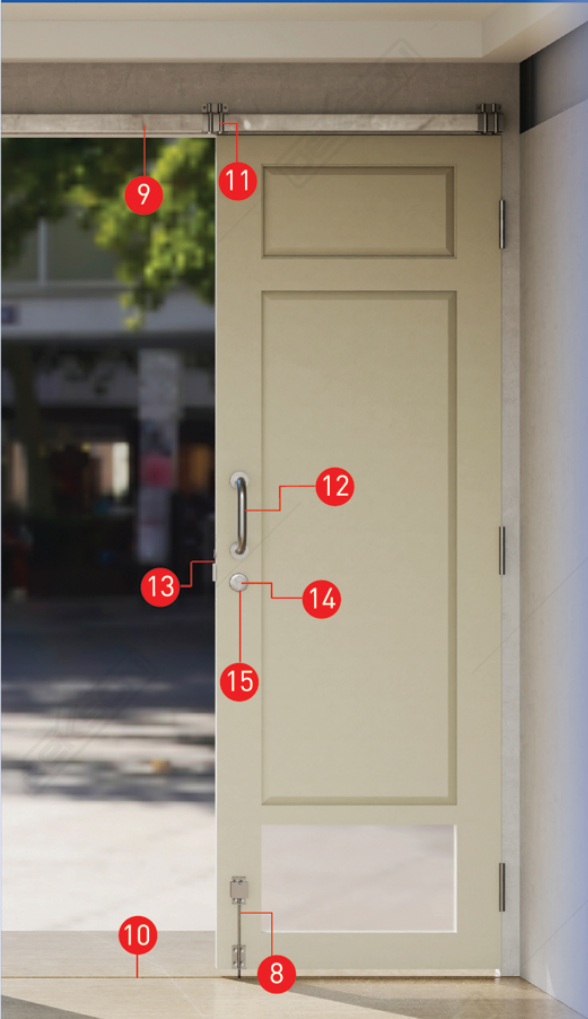

Gambar Potongan

13 MORTISE ROLLER



MTS RL DL 8585 SSS

14 DOUBLE CYLINDER



CYL DC DL 60 MM SN

15 ESCUTCHEON



ESCN 855 SSS

16 RODA ATAS TENGAH "RD4"
Digunakan sebagai alternatif apabila maksimum berat daun pintu 100 kg



WH 8144 RD4 (57MM) GALV

17 BAUT BREKET & FISHER



BF 3/8x2,5" (38/57MM) GALV
BF 3/8x3" (38/57MM) GALV

Spesifikasi

Maksimum tinggi pintu : 2400 mm
Maksimum berat pintu : 80 kg/daun pintu
Tebal pintu : 40 - 50 mm

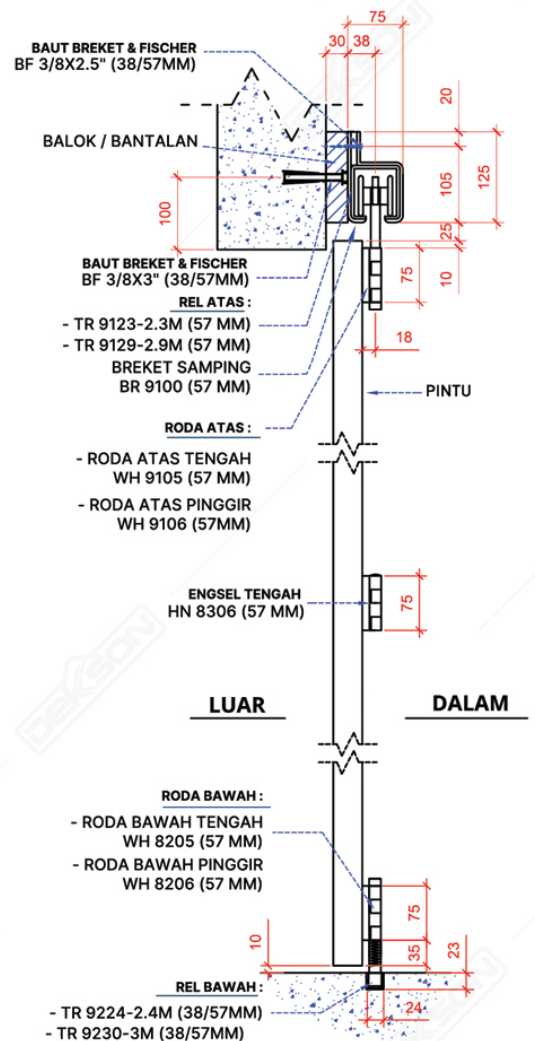

PINTU DORONG LIPAT EKSTERIOR

RODA "RODA L"



① RODA ATAS TENGAH "L"



WH 8195-L (57MM)
GALV

② ENGSEL TENGAH



HN 8306 (57MM)
GALV

③ RODA BAWAH TENGAH



WH 8205 (57MM)
GALV

④ ENGSEL KUPU - KUPU



ESS EL 4X3X3MM 2BB SSS

⑤ GREDEL TANAM PLAT



FBP 8" SSS

⑥ GREDEL BAWAH BIASA

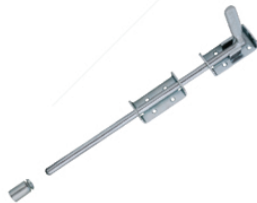

BB 9204 (38/57MM)
GALV

⑦ REL ATAS



TR 9123 - 2.3M (57MM) GALV
TR 9129 - 2.9M (57MM) GALV

⑧ REL BAWAH



TR 9224 - 2.4M (38/57MM) GALV
TR 9230 - 3M (38/57MM) GALV

⑨ BREKET SAMPING



BR 9100 (57MM)
GALV

⑩ PULL HANDLE



PH D855 19x195x152 SSS

⑪ MORTISE ROLLER



MTS RL DL 8585 SSS

⑫ DOUBLE CYLINDER



CYL DC DL 60 MM SN



GAMBAR TAMPAK DEPAN

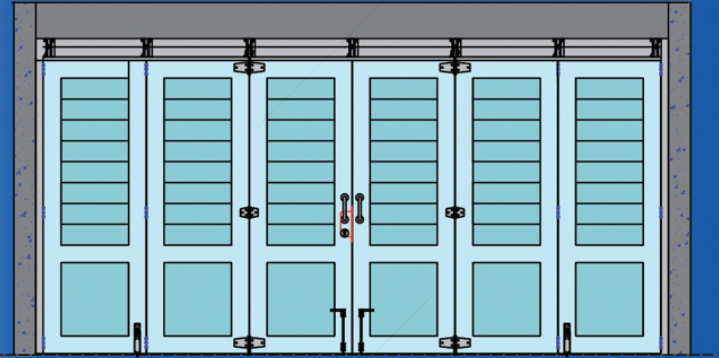

GAMBAR TAMPAK ATAS

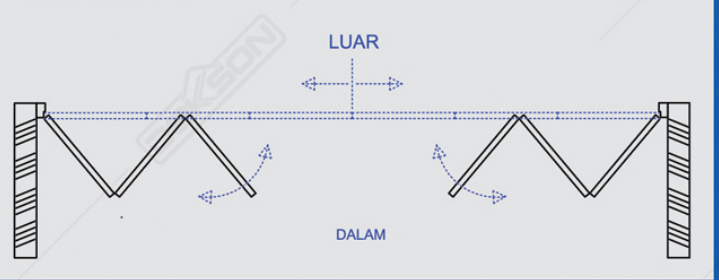

Gambar Potongan

13 ESCUTCHEON



ESCN 855 SSS

14 RODA ATAS PINGGIR "L"



WH 8196-L (57MM) GALV

15 RODA BAWAH PINGGIR



WH 8206 (57 MM)

16 BAUT BREKET & FISHER



BF 3/8x2,5" (38/57MM) GALV
BF 3/8x3" (38/57MM) GALV

Spesifikasi

Maksimum tinggi pintu : 2400 mm
Maksimum berat pintu : 80 kg/daun pintu
Tebal pintu : 40 - 50 mm

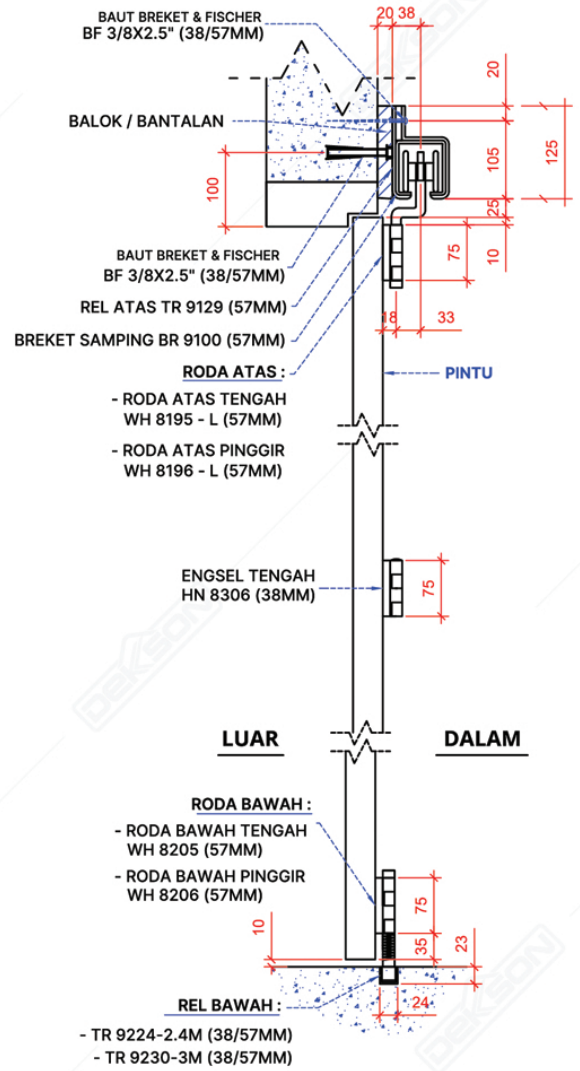

PINTU DORONG MENIKUNG EKSTERIOR

RODA "STANDARD"

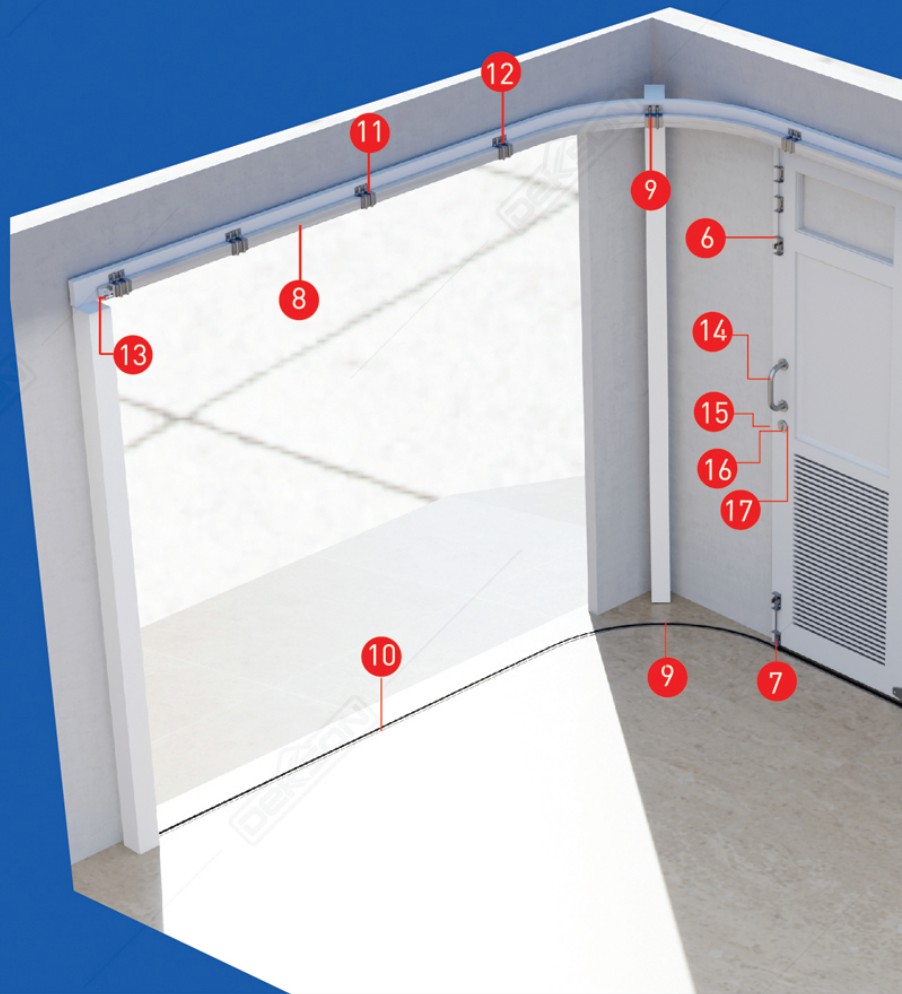

① RODA ATAS TENGAH



WH 9105 (57MM)
GALV

② RODA ATAS PINGGIR



WH 9106 (57MM)
GALV

③ ENGSEL TENGAH



HN 8306 (57MM)
GALV

④ RODA BAWAH TENGAH



WH 8205 (57MM)
GALV

⑤ RODA BAWAH PINGGIR



WH 8206 (57MM)
GALV

⑥ GREDEL ATAS



BB 8104-UK 75CM (38/57MM)
GALV

⑦ GREDEL BAWAH BERODA



BB 8204 (38/57MM)
GALV

⑧ REL ATAS



TR 9123 - 2.3M (57MM) GALV
TR 9129 - 2.9M (57MM) GALV

⑨ REL TIKUNG ATAS & BAWAH

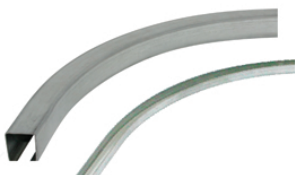

TR 9190 (57MM)
GALV

⑩ REL BAWAH



TR 9224 - 2.4M (38/57MM) GALV
TR 9230 - 3M (38/57MM) GALV

⑪ BREKET SAMPING



BR 9100 (57MM)
GALV

⑫ BREKET SAMBUNG



BR 9101 (57MM)
GALV

GAMBAR TAMPAK DEPAN

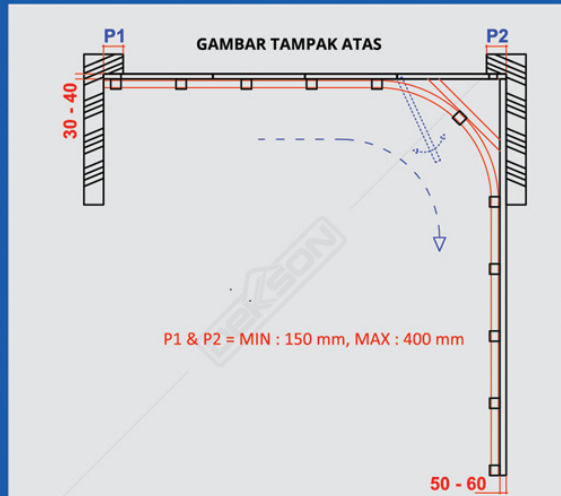
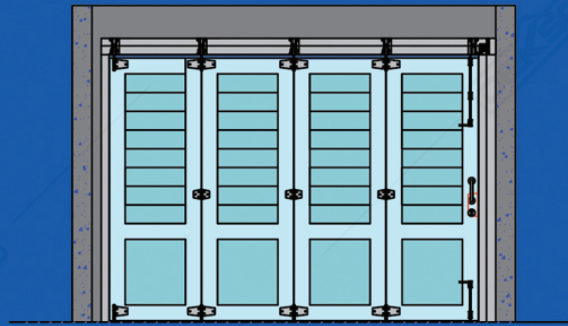

Gambar Potongan

13 TUTUP BREKET & STOPPER



BR 9102 (57MM)
GALV

14 PULL HANDLE



PH D855 19x195x152 SSS

15 MORTISE SLIDING



MTS SLD DL 84100 N

16 DOUBLE CYLINDER



CYL DC DL 60 MM SN

17 ESCUTCHEON



ESCN 855 SSS

18 BAUT BREKET & FISHER



BF 3/8x2,5" (38/57MM) GALV
BF 3/8x3" (38/57MM) GALV
BF 3/8x4" (38/57MM) GALV

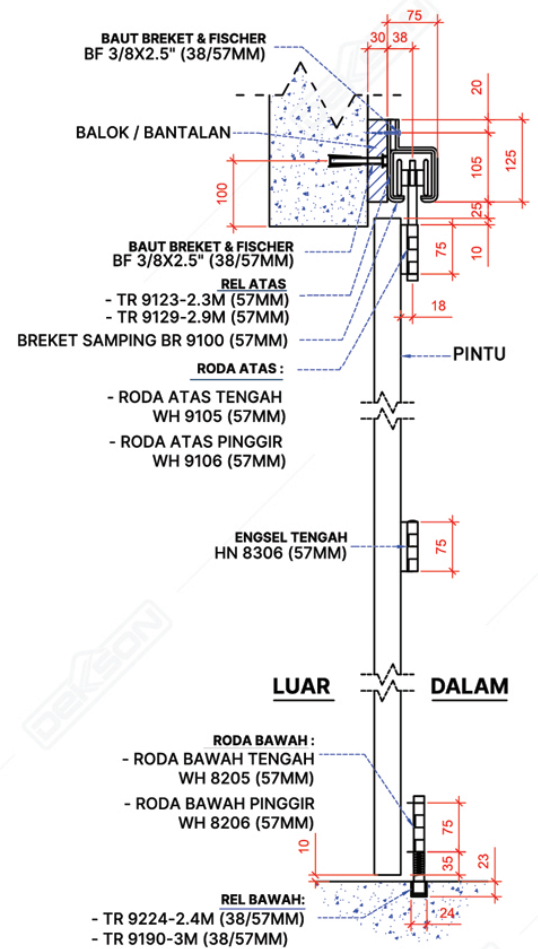

Spesifikasi

Maksimum tinggi pintu : 2400 mm
Maksimum berat pintu : 80 kg/daun pintu
Maksimum lebar pintu : 820 mm
Tebal pintu : 40 - 50 mm

PINTU DORONG LIPAT TENGAH EKSTERIOR



1 RODA ATAS LIPAT TENGAH



WH 7185 (57MM)
GALV

2 RODA ATAS LIPAT TENGAH "RD4"

Digunakan sebagai alternatif apabila maksimum berat daun pintu 100 kg



WH 7184 - RD4 (57MM)
GALV

3 ENGSEL KUPU - KUPU



ESS EL 4X3X3MM 2BB SSS

4 GRENDDEL TANAM PLAT



FBP 8" SSS

5 REL ATAS



TR 9123 - 2.3M (57MM) GALV
TR 9129 - 2.9M (57MM) GALV

6 REL BAWAH



TR 9224 - 2.4M (38/57MM) GALV
TR 9230 - 3M (38/57MM) GALV

7 BREKET GANTUNG



BR 9185 (57MM)
GALV

8 PULL HANDLE



PH D855 19x195x152 SSS

9 MORTISE ROLLER



MTS RL DL 8585 SSS

10 DOUBLE CYLINDER



CYL DC DL 60 MM SN

11 ESCUTCHEON



ESCN 855 SSS

12 RODA BAWAH LIPAT TENGAH



WH 7285 (38/57MM)
GALV

13 BAUT BREKET & FISHER



BF 3/8x2,5" (38/57MM) GALV
BF 3/8x3" (38/57MM) GALV



Gambar Potongan

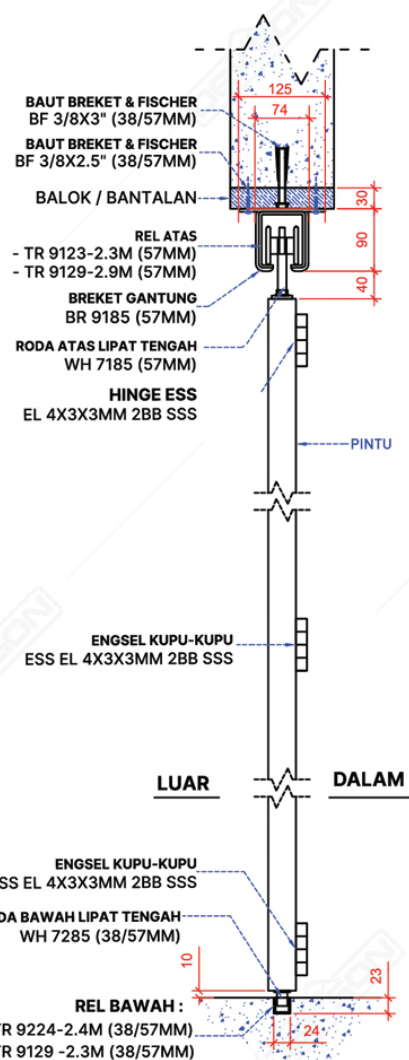
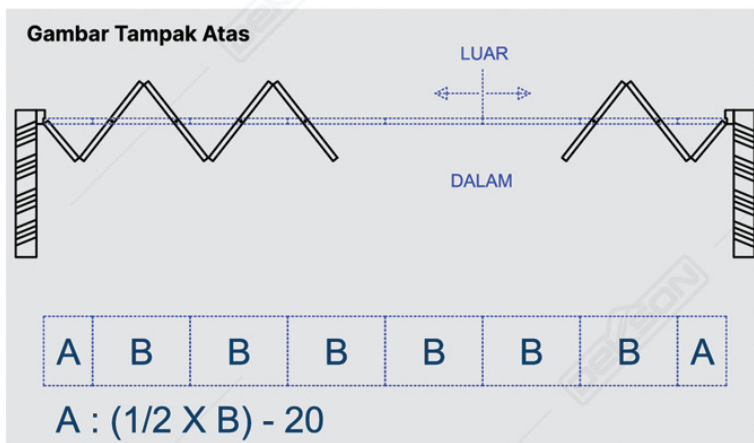

Gambar Tampak Depan

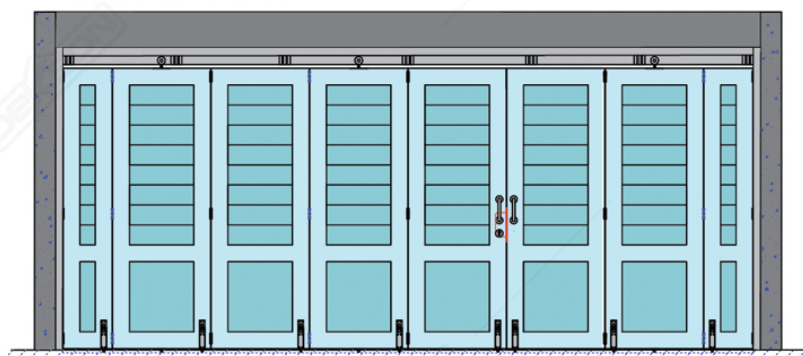

Spesifikasi
 Maksimum tinggi pintu : 2400 mm
 Maksimum berat pintu : 80 & 100 kg/daun pintu
 Tebal pintu : 40 - 50 mm

PINTU DORONG LIPAT PINGGIR INTERIOR



1 RODA ATAS LIPAT PINGGIR



WH 7186 (57MM)
GALV

2 RODA ATAS LIPAT PINGGIR "RD4"

Digunakan sebagai alternatif apabila maksimum berat daun pintu 100 kg



WH 7174 - RD4 (57MM)
GALV

3 ENGSEL KUPU - KUPU



ESS EL 4X3X3MM 2BB SSS

4 GRENDDEL TANAM PLAT



FBP 8" SSS

5 REL ATAS



TR 9123 - 2.3M (57MM) GALV
TR 9129 - 2.9M (57MM) GALV

6 REL BAWAH



TR 9224 - 2.4M (38/57MM) GALV
TR 9230 - 3M (38/57MM) GALV

7 BREKET GANTUNG



BR 9185 (57MM)
GALV

8 PULL HANDLE



PH D855 19x195x152 SSS

9 MORTISE ROLLER



MTS RL DL 8585 SSS

10 DOUBLE CYLINDER



CYL DC DL 60 MM SN

11 ESCUTCHEON



ESCN 855 SSS

12 RODA BAWAH LIPAT PINGGIR



WH 7286 (57MM)
GALV

13 BAUT BREKET & FISHER



BF 3/8x2,5" (38/57MM) GALV
BF 3/8x3" (38/57MM) GALV



Gambar Potongan

Gambar Tampak Depan



Gambar Tampak Atas

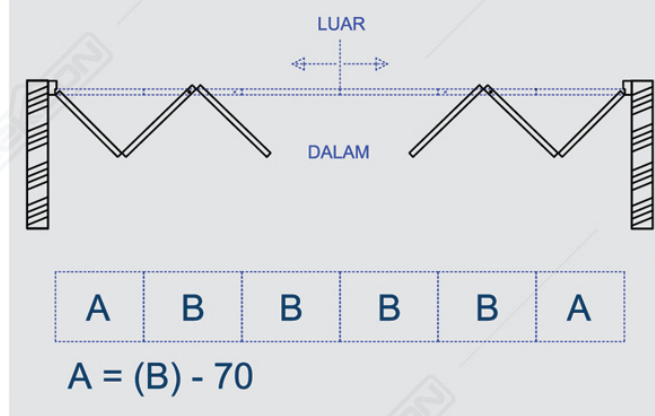

Spesifikasi

- Maksimum tinggi pintu : 2400 mm
- Maksimum berat pintu : 80 & 100 kg/daun pintu
- Tebal pintu : 40 - 50 mm

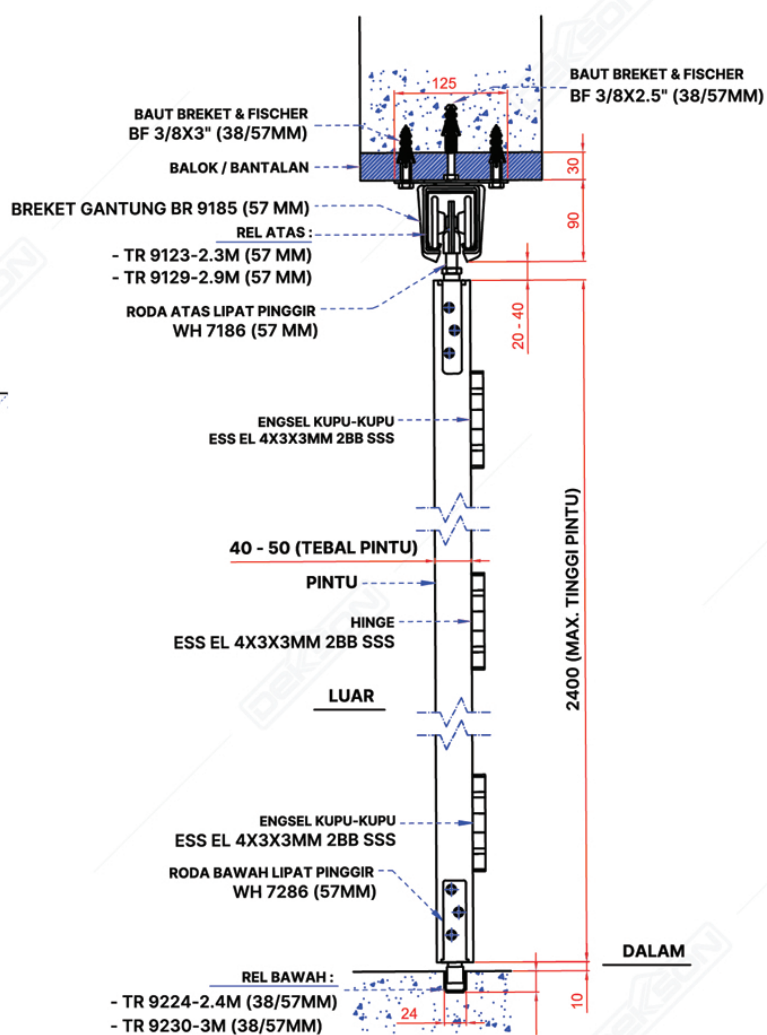

INDEKS AKSESORIS PINTU DORONG

(untuk ukuran 80 Kg)



RODA ATAS LIPAT PINGGIR

Kode Barang : WH 7186 (57MM) GALV
Kode Komputer : 1601571861



RODA ATAS LIPAT PINGGIR RD4

Kode Barang : WH 7174 - RD 4 (57MM) GALV
Kode Komputer : 1601571741



RODA ATAS LIPAT TENGAH

Kode Barang : WH 7185 (57MM) GALV
Kode Komputer : 1601571851



RODA ATAS LIPAT TENGAH RD4

Kode Barang : WH 7184 - RD 4 (57MM) GALV
Kode Komputer : 1601571841



RODA ATAS TENGAH

Kode Barang : WH 9105 (57MM) GALV
Kode Komputer : 1601591051



RODA ATAS TENGAH RD4

Kode Barang : WH 8144 - RD 4 (57MM) GALV
Kode Komputer : 1601581441



RODA ATAS TENGAH "L"

Kode Barang : WH 8195 - L (57MM) GALV
Kode Komputer : 1601581951



RODA ATAS PINGGIR "L"

Kode Barang : WH 8196 - L (57MM) GALV
Kode Komputer : 1601581961



RODA ATAS PINGGIR

Kode Barang : WH 9106 (57MM) GALV
Kode Komputer : 1601591061

INDEKS AKSESORIS PINTU DORONG

(untuk ukuran 80 Kg)



RODA BAWAH LIPAT PINGGIR

Kode Barang : WH 7286 (57MM) GALV
Kode Komputer : 1601572861



RODA BAWAH LIPAT TENGAH

Kode Barang : WH 7285 (38/57MM) GALV
Kode Komputer : 1601572851



RODA BAWAH TENGAH

Kode Barang : WH 8205 (57MM) GALV
Kode Komputer : 1601582051



RODA BAWAH PINGGIR

Kode Barang : WH 8206 (57MM) GALV
Kode Komputer : 1601582061



ENGSEL TENGAH

Kode Barang : HN 8306 (57MM) GALV
Kode Komputer : 1601583061



BREKET SAMPING

Kode Barang : BR 9100 (57MM) GALV
Kode Komputer : 1601591001



BREKET SAMPUNG

Kode Barang : BR 9101 (57MM) GALV
Kode Komputer : 1601591011



BREKET GANTUNG

Kode barang : BR 9185 (57MM) GALV
Kode Komputer : 1601591851



TUTUP BREKET & STOPPER

Kode Barang : BR 9102 (57MM) GALV
Kode Komputer : 1601591021

INDEKS AKSESORIS PINTU DORONG

(untuk ukuran 80 Kg)



GREDEL ATAS DEKSON

Kode Barang : BB 8104-UK 75CM (38/57MM) GALV
Kode Komputer : 1601581041

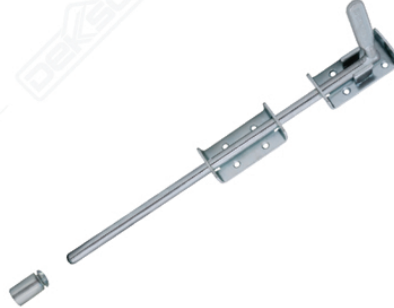

GREDEL BAWAH BIASA

Kode Barang : BB 9204 (38/57MM) GALV
Kode Komputer : 1601592041



GREDEL BAWAH BERODA

Kode Barang : BB 8204 (38/57MM) GALV
Kode Komputer : 1601582041



REL ATAS

Kode Barang : TR 9123 - 2.3M (57MM) GALV
Kode Komputer : 1601591231

Kode Barang : TR 9129 - 2.9M (57MM) GALV
Kode Komputer : 1601591291



REL BAWAH

Kode Barang : TR 9224 - 2.4M (38/57MM) GALV
Kode Komputer : 1601592241

Kode Barang : TR 9230 - 3M (38/57MM) GALV
Kode Komputer : 1601592301

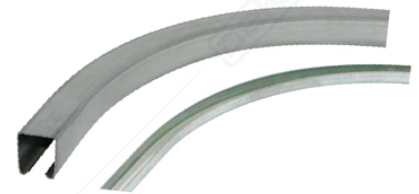

REL TIKUNG ATAS & BAWAH

Kode Barang : TR 9190 (57MM) GALV
Kode Komputer : 1601591901



MORTISE SLIDING

Kode Barang : MTS SLD DL 84100 N
Kode Komputer : 201121521



MORTISE ROLLER

Kode Barang : MTS RL DL 8585 SSS
Kode Komputer : 201121521



ENGSEL KUPU - KUPU

Kode Barang : ES EL 4x3x3MM 2BB SSS
Kode Komputer : 101131321

INDEKS AKSESORIS PINTU DORONG

(untuk ukuran 80 Kg)



ESCUTCHEON

Kode Barang : ESCN 855 SSS
Kode Komputer : 901108551



DOUBLE CYLINDER

Kode Barang : CYL DC DL 60MM SN
Kode Komputer : 301211601



PULL HANDLE

Kode Barang : PH D855 19x195x152 SSS
Kode Komputer : 801180051



GRENDEL TANAM PLAT

Kode Barang : FBP 8" SSS
Kode Komputer : 1701054501



BAUT BREKET & FISHER

Kode Barang : BF 3/8x2.5" (38/57 MM) GALV
Kode Komputer : 1601538251

Kode Barang : BF 3/8x3" (38/57 MM) GALV
Kode Komputer : 1601538351

Kode Barang : BF 3/8x4" (38/57 MM) GALV
Kode Komputer : 1601538451

SLIDE AND FOLD DOOR



Table of Contents :

ACCESSORIES FOR SLIDE & FOLD DOOR CONTENT (60 Kg)

Pintu dorong lipat eksterior roda "STANDARD" **17**

- Skema Pintu Dorong
- Gambar Tampak, Gambar Potongan, dan Gambar Denah

Pintu dorong lipat eksterior roda "L" **19**

- Skema Pintu Dorong
- Gambar Tampak, Gambar Potongan, dan Gambar Denah

Pintu dorong menikung eksterior roda "STANDARD" **21**

- Skema Pintu Dorong
- Gambar Tampak, Gambar Potongan, dan Gambar Denah

Pintu dorong lipat tengah interior **23**

- Skema Pintu Dorong
- Gambar Tampak, Gambar Potongan, dan Gambar Denah

Pintu dorong lipat pinggir interior **25**

- Skema Pintu Dorong
- Gambar Tampak, Gambar Potongan, dan Gambar Denah

Indeks aksesories pintu dorong lipat **27**

- Skema Pintu Dorong
- Gambar Tampak, Gambar Potongan, dan Gambar Denah

PINTU DORONG LIPAT EKSTERIOR

RODA "STANDARD"



① RODA ATAS TENGAH



WH 39105 (38 MM)
GALV

② RODA ATAS PINGGIR



WH 39106 (38 MM)
GALV

③ ENGSEL TENGAH



HN 38306 (38 MM)
GALV

④ RODA BAWAH TENGAH



WH 38205 (38 MM)
GALV

⑤ RODA BAWAH PINGGIR



WH 38206 (38 MM)
GALV

⑥ ENGSEL KUPU - KUPU



ESS EL 4X3X3MM 2BB SSS

⑦ GREDEL TANAM PLAT



FBP 8" SSS

⑧ GREDEL BAWAH BIASA



BB 9204 (38/57MM)
GALV

⑨ REL ATAS DEKSON



TR 39123 - 2,3M (38 MM) GALV
TR 39129 - 2,9M (38 MM) GALV

⑩ REL BAWAH DEKSON



TR 9224 - 2,4M (38/57MM) GALV
TR 9230 - 3M (38/57MM) GALV

⑪ BREKET SAMPING



BR 39100 (38MM)
GALV

⑫ PULL HANDLE



PH D855 19x195x152 SSS

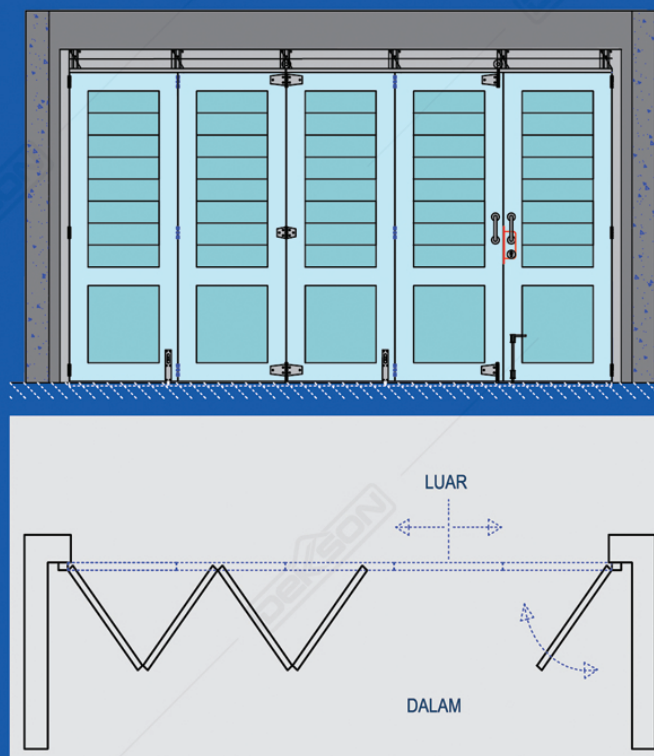

13 MORTISE ROLLER



MTS RL DL 8585 SSS

15 ESCUTCHEON



ESCN 855 SSS

17 BAUT BREKET & FISHER DEKSON



BF 3/8x2,5" (38/57MM) GALV
BF 3/8x3" (38/57MM) GALV

14 DOUBLE CYLINDER



CYL DC DL 60 MM SN

16 RODA ATAS TENGAH "RD4"
Digunakan sebagai alternatif apabila maksimum berat daun pintu 80 kg



WH 38144-RD 4
(38 MM) GALV

Spesifikasi

Maksimum tinggi pintu : 2400 mm
Maksimum berat pintu : 60kg/daun pintu
Tebal pintu : 40 - 50 mm

Gambar Potongan

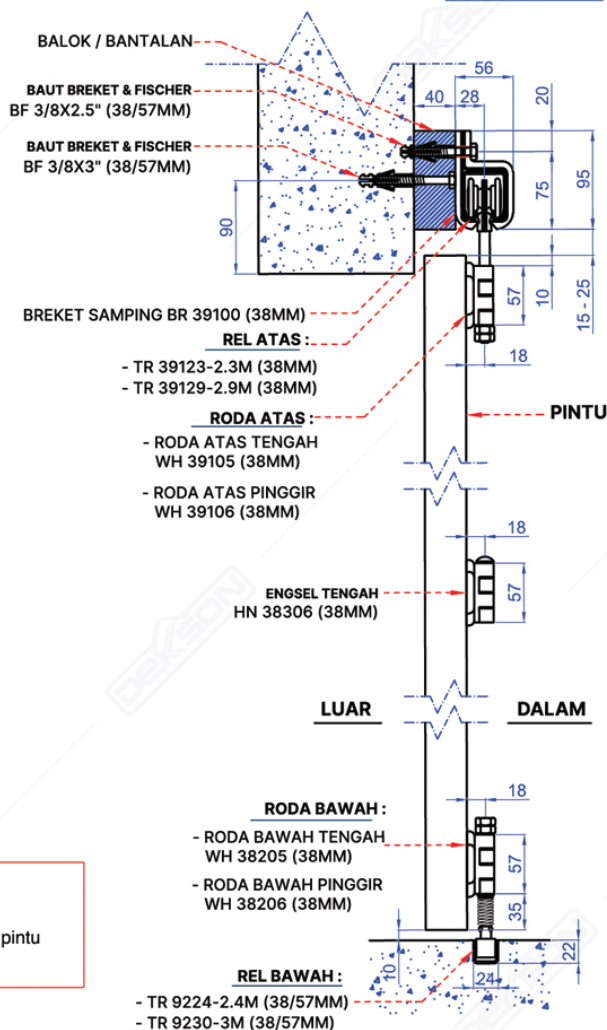

PINTU DORONG LIPAT EKSTERIOR

RODA "RODA L"



① RODA ATAS TENGAH "L"



WH 38195-L (38 MM)
GALV

② ENGSEL TENGAH



HN 38306 (38 MM)
GALV

③ RODA BAWAH TENGAH



WH 38205 (38 MM)
GALV

④ ENGSEL KUPU - KUPU



ESS EL 4X3X3MM 2BB SSS

⑤ GREDEL TANAM PLAT



FBP 8" SSS

⑥ GREDEL BAWAH BIASA

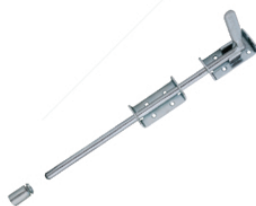

BB 9204 (38/57 MM)
GALV

⑦ REL ATAS



TR 39123 - 2,3M (38 MM) GALV
TR 39129 - 2,9M (38 MM) GALV

⑧ REL BAWAH 3M / 2,4 M



TR 9224 - 2.4M (38/57MM) GALV
TR 9230 - 3M (38/57MM) GALV

⑨ BREKET SAMPING



BR 39100 (38MM)
GALV

⑩ PULL HANDLE



PH D855 19x195x152 SSS

⑪ MORTISE ROLLER



MTS RL DL 8585 SSS

⑫ DOUBLE CYLINDER



CYL DC DL 60 MM SN



Gambar Tampak Depan

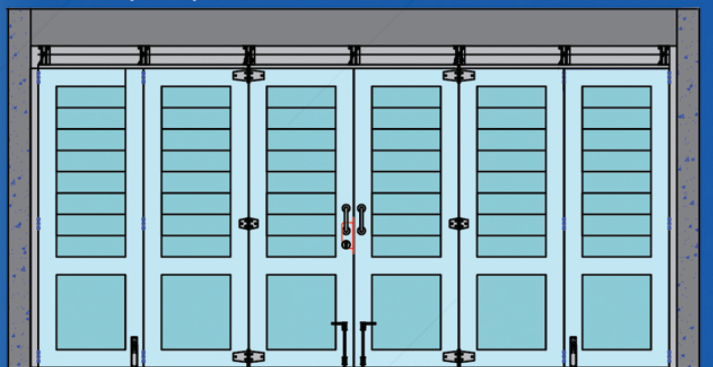

Gambar Tampak Atas

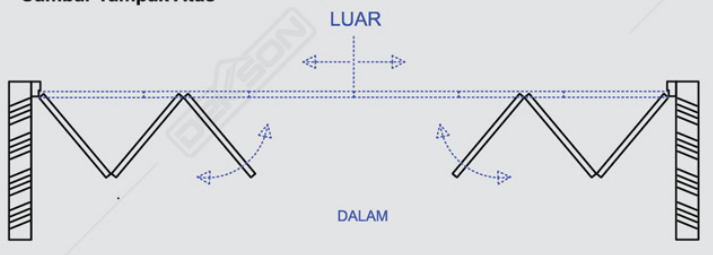

Gambar Potongan

13 ESCUTCHEON



ESCN 855 SSS

14 RODA ATAS PINGGIR "L"



WH 38196 - L (38 MM)
GALV

15 RODA BAWAH PINGGIR



WH 38206 (38 MM)
GALV

16 BAUT BREKET & FISHER



BF 3/8x2,5" (38/57MM) GALV
BF 3/8x3" (38/57MM) GALV

Spesifikasi



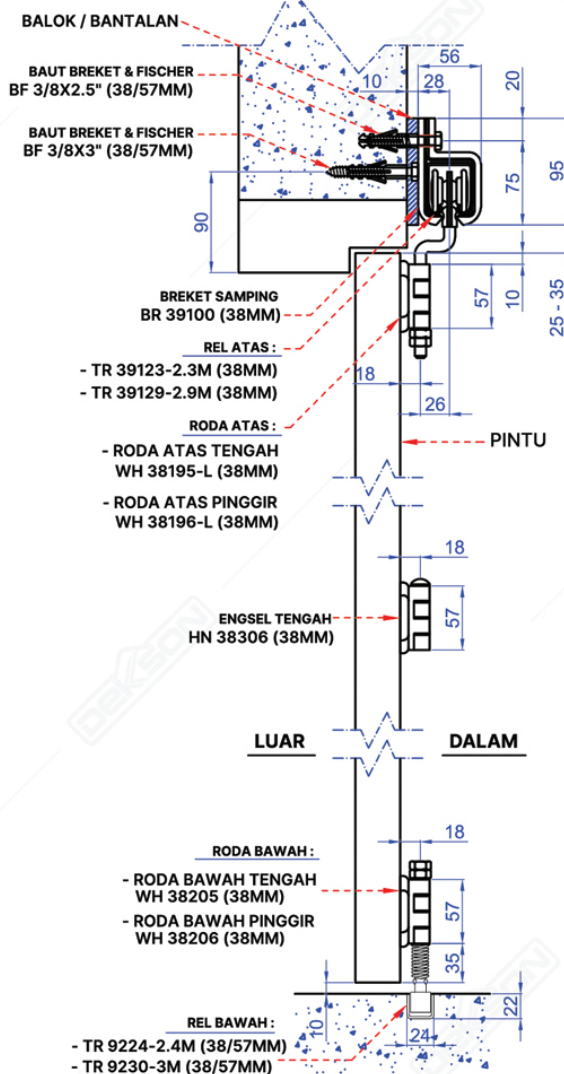





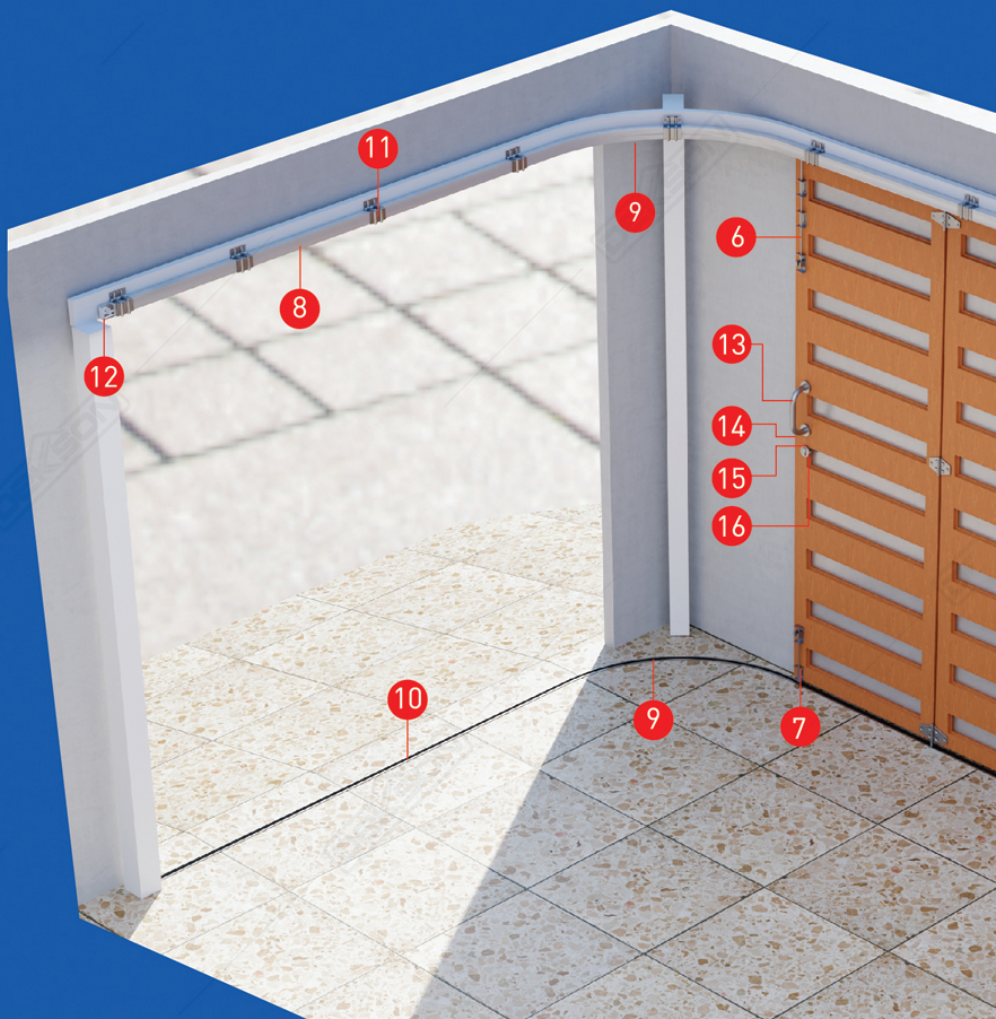



Maksimum tinggi pintu : 2400 mm
Maksimum berat pintu : 60 kg/daun pintu
Tebal pintu : 40 - 50 mm

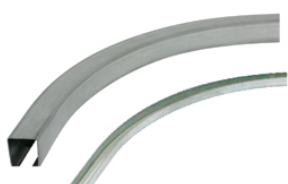

PINTU DORONG MENIKUNG EKSTERIOR

RODA "STANDARD"



- | | | | |
|--|---|---|--|
| <p>① RODA ATAS TENGAH</p>  <p>WH 39105 (38 MM) GALV</p> | <p>② RODA ATAS PINGGIR</p>  <p>WH 39106 (38 MM) GALV</p> | <p>③ ENGSEL TENGAH</p>  <p>HN 38306 (38 MM) GALV</p> | <p>④ RODA BAWAH TENGAH</p>  <p>WH 38205 (38 MM) GALV</p> |
| <p>⑤ RODA BAWAH PINGGIR</p>  <p>WH 38206 (38 MM) GALV</p> | <p>⑥ GRENDDEL ATAS</p>  <p>BB 8104 (38/57MM) GALV</p> | <p>⑦ GRENDDEL BAWAH BERODA</p>  <p>BB 8204 (38/57 MM) GALV</p> | <p>⑧ REL ATAS DEKSON</p>  <p>TR 39123 - 2,3M (38 MM) GALV TR 39129 - 2,9M (38 MM) GALV</p> |
| <p>⑨ REL TIKUNG ATAS & BAWAH</p>  <p>TR 39190 (38 MM) GALV</p> | <p>⑩ REL BAWAH DEKSON</p>  <p>TR 9224 - 2,4M (38/57MM) GALV TR 9230 - 3M (38/57MM) GALV</p> | <p>⑪ BREKET SAMPING</p>  <p>BR 39100 (38 MM) GALV</p> | <p>⑫ TUTUP BREKET & STOPPER</p>  <p>BR 39102 (38MM) GALV</p> |

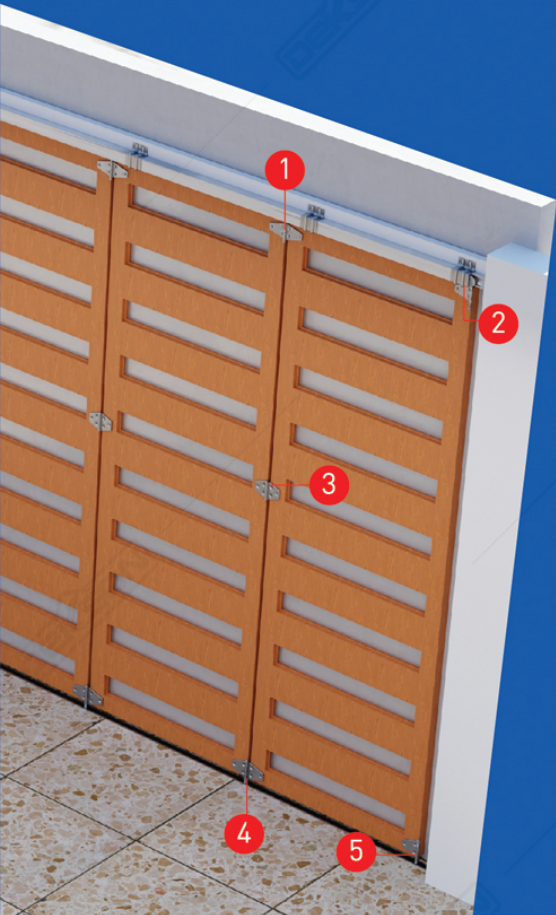

Gambar Tampak Depan



Gambar Tampak Atas

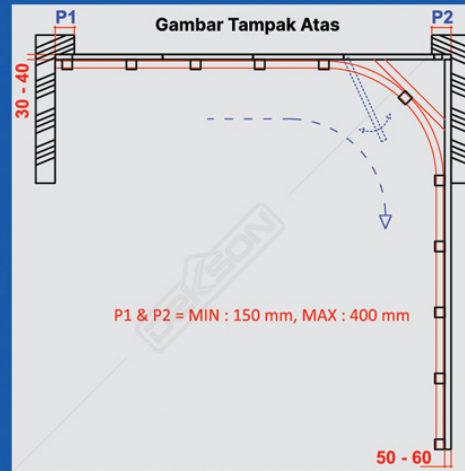

Gambar Potongan

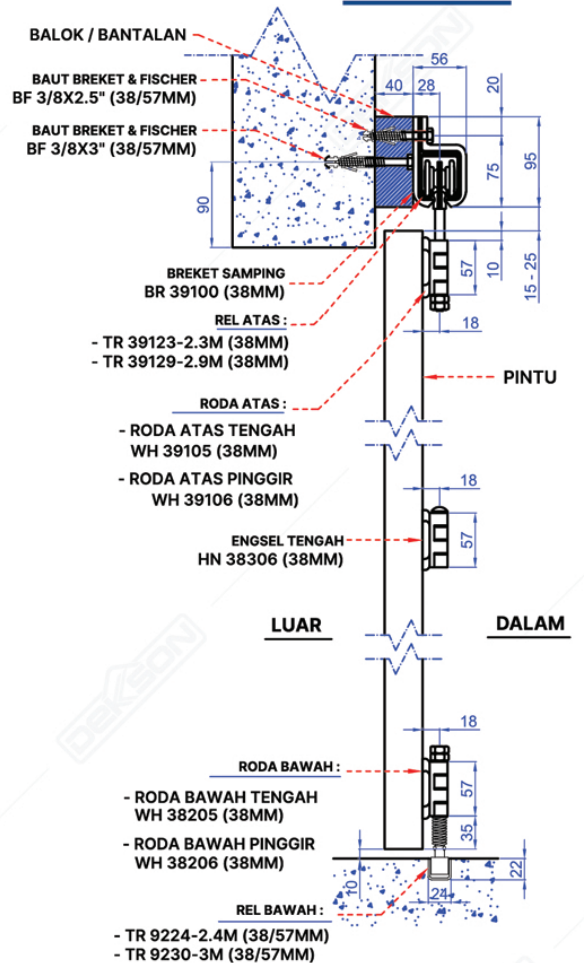

Spesifikasi
 Maksimum tinggi pintu : 2400 mm
 Maksimum berat pintu : 60 kg/daun pintu
 Tebal pintu : 40 - 50 mm

13 PULL HANDLE



PH D855 19x195x152 SSS

14 MORTISE SLIDING



MTS SLD DL 84100 N SSS

15 DOUBLE CYLINDER



CYL DC DL 60 MM SN

16 ESCUTCHEON



ESCN 855 SSS

17 BAUT BREKET & FISHER DEKSON



BF 3/8x2,5" (38/57MM) GALV
 BF 3/8x3" (38/57MM) GALV
 BF 3/8x4" (38/57MM) GALV

PINTU DORONG LIPAT TENGAH EKSTERIOR



1 RODA ATAS LIPAT TENGAH



WH 37185 (38 MM) GALV

2 RODA ATAS LIPAT TENGAH "RD4"

Digunakan sebagai alternatif apabila maksimum berat daun pintu 80 kg



WH 37184-RD 4 (38 MM) GALV

3 ENGSEL KUPU - KUPU



ESS EL 4X3X3MM 2BB SSS

4 GRENDAL TANAM PLAT



FBP 8" SSS

5 REL ATAS DEKSON



TR 39123 - 2,3M (38 MM) GALV
TR 39129 - 2,9M (38 MM) GALV

6 REL BAWAH DEKSON



TR 9224 - 2.4M (38/57MM) GALV
TR 9230 - 3M (38/57MM) GALV

7 BREKET GANTUNG



BR 39185 (38MM) GALV

8 PULL HANDLE



PH D855 19x195x152 SSS

9 MORTISE ROLLER



MTS RL DL 8585 SSS

10 DOUBLE CYLINDER



CYL DC DL 60 MM SN

11 ESCUTCHEON



ESCN 855 SSS

12 RODA BAWAH LIPAT TENGAH



WH 7285 (38/57MM) GALV

13 BAUT BREKET & FISHER DEKSON



BF 3/8x2,5" (38/57MM) GALV
BF 3/8x3" (38/57MM) GALV



Gambar Potongan

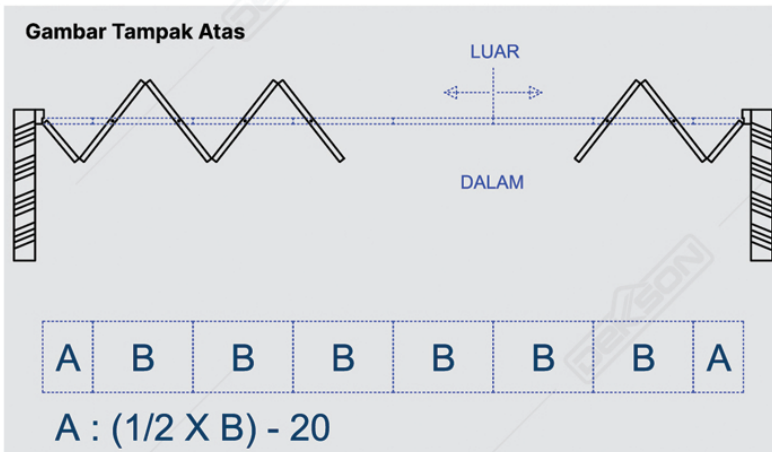

Gambar Tampak Depan

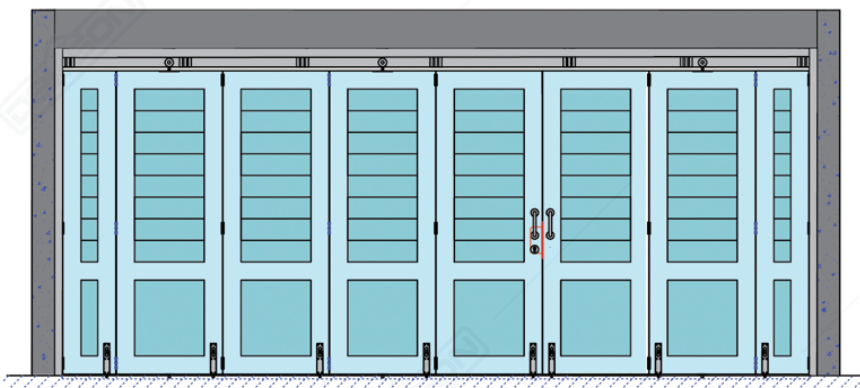

Spesifikasi

Maksimum tinggi pintu : 2400 mm
 Maksimum berat pintu : 60 & 80 kg/daun pintu
 Tebal pintu : 40 - 50 mm

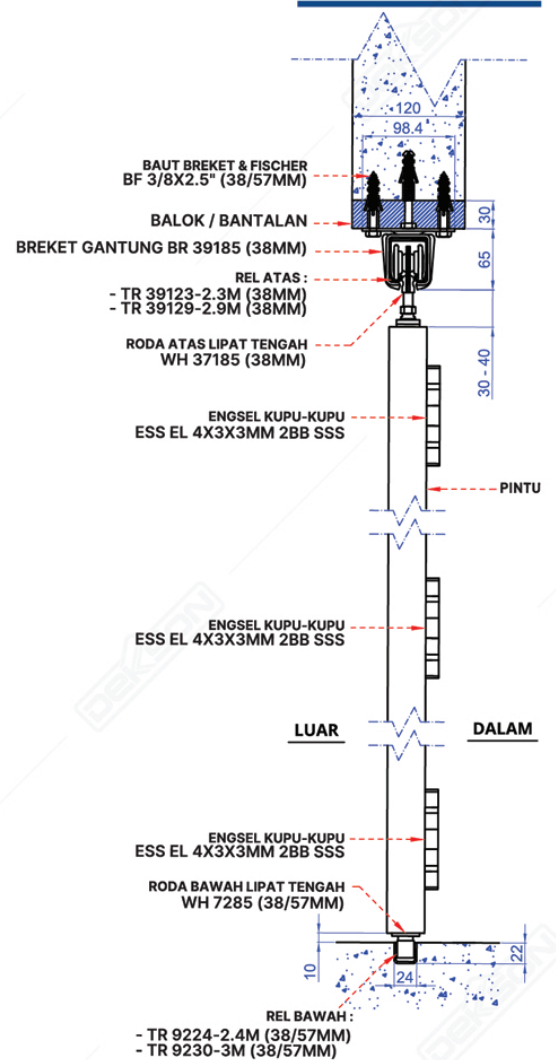

PINTU DORONG LIPAT PINGGIR INTERIOR



① RODA ATAS LIPAT PINGGIR



WH 37186 (38 MM)
GALV

② RODA ATAS LIPAT PINGGIR "RD4"

Digunakan sebagai alternatif apabila maksimum berat daun pintu 80 kg



WH 37174-RD 4 (38 MM)
GALV

③ ENGSEL KUPU - KUPU



ESS EL 4X3X3MM 2BB SSS

④ GRENDEL TANAM PLAT



FBP 8" SSS

⑤ REL ATAS DEKSON



TR 39123 - 2,3M (38 MM) GALV
TR 39129 - 2,9M (38 MM) GALV

⑥ REL BAWAH DEKSON



TR 9224 - 2.4M (38/57MM) GALV
TR 9230 - 3M (38/57MM) GALV

⑦ BREKET GANTUNG



BR 39185 (38MM)
GALV

⑧ PULL HANDLE



PH D855 19x195x152 SSS

⑨ MORTISE ROLLER



MTS RL DL 8585 SSS

⑩ DOUBLE CYLINDER



CYL DC DL 60 MM SN

⑪ ESCUTCHEON



ESCN 855 SSS

⑫ RODA BAWAH LIPAT PINGGIR



WH 37286 (38MM)
GALV

⑬ BAUT BREKET & FISHER DEKSON



BF 3/8x2,5" (38/57MM) GALV
BF 3/8x3" (38/57MM) GALV



Gambar Tampak Depan

Gambar Potongan

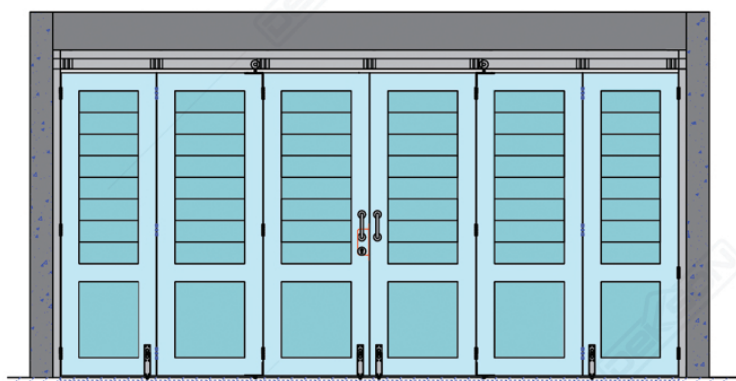

Gambar Tampak Atas

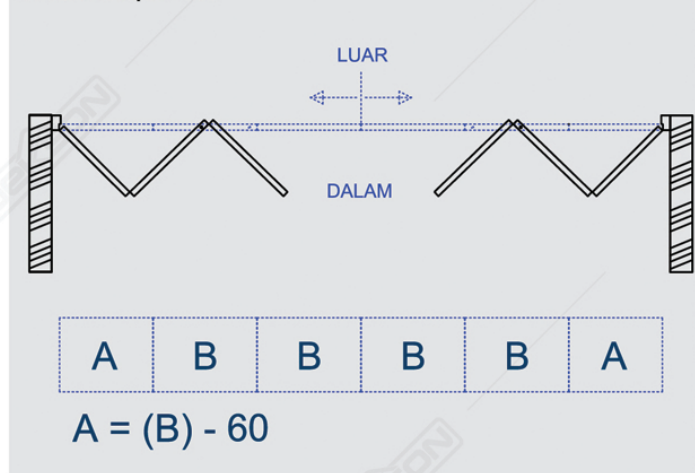

Spesifikasi

Maksimum tinggi pintu : 2400 mm
 Maksimum berat pintu : 60 & 80 kg/daun pintu
 Tebal pintu : 40 - 50 mm

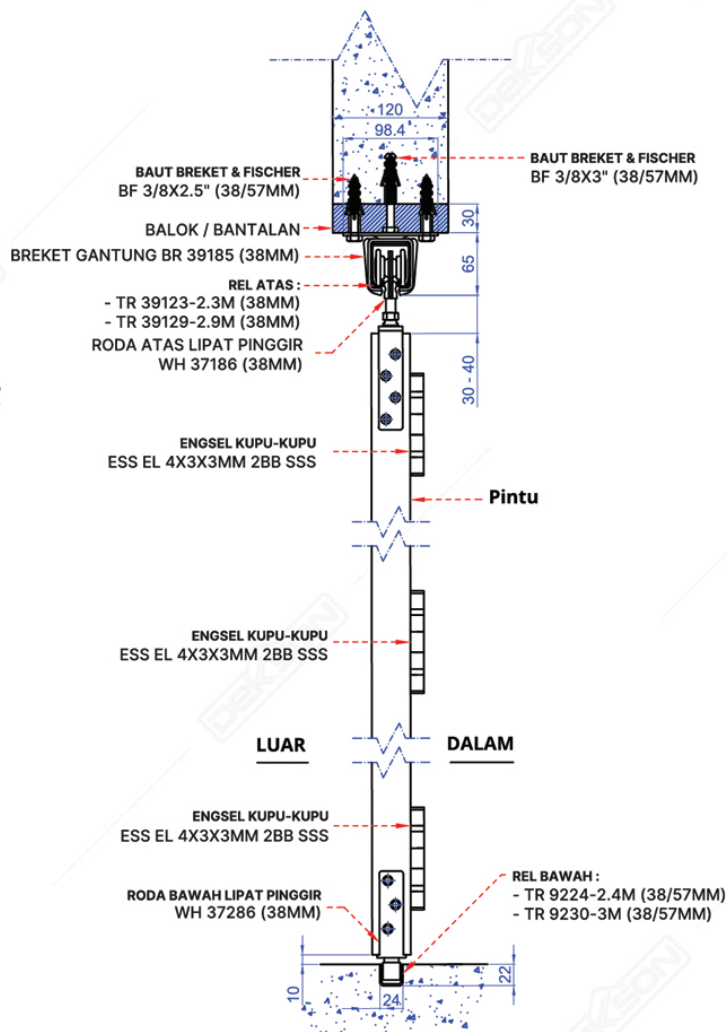

INDEKS AKSESORIS PINTU DORONG

(untuk ukuran 60 Kg)



RODA ATAS LIPAT PINGGIR

Kode Barang : WH 37186 (38MM) GALV
Kode Komputer : 1601537161



RODA ATAS LIPAT PINGGIR RD4

Kode Barang : WH 37174 - RD 4
(38MM) GALV
Kode Komputer : 1601537171



RODA ATAS LIPAT TENGAH

Kode Barang : WH 37185 (38MM) GALV
Kode Komputer : 1601537151



RODA ATAS LIPAT TENGAH RD4

Kode Barang : WH 37184 - RD 4
(38MM) GALV
Kode Komputer : 1601537181



RODA ATAS TENGAH

Kode Barang : WH 39105 (38MM) GALV
Kode Komputer : 1601539151



RODA ATAS TENGAH RD4

Kode Barang : WH 38144 - RD 4
(38MM) GALV
Kode Komputer : 1601538141



RODA ATAS TENGAH "L"

Kode Barang : WH 38195 - L
(38MM) GALV
Kode Komputer : 1601538191



RODA ATAS PINGGIR "L"

Kode Barang : WH 38196 - L
(38MM) GALV
Kode Komputer : 1601538161



RODA ATAS PINGGIR

Kode Barang : WH 39106 (38MM) GALV
Kode Komputer : 1601539101



RODA BAWAH LIPAT PINGGIR

Kode Barang : 37286 (38MM) GALV
Kode Komputer : 1601572871



RODA BAWAH LIPAT TENGAH

Kode Barang : WH 7285
(38/57MM) GALV
Kode Komputer : 1601572851



RODA BAWAH TENGAH

Kode Barang : WH 38205
(38MM) GALV
Kode Komputer : 1601538201



RODA BAWAH PINGGIR

Kode Barang : WH 38206 (38MM) GALV
Kode Komputer : 1601538261



ENGSEL TENGAH

Kode Barang : HN 38306 (38MM) GALV
Kode Komputer : 1601538301



BREKET SAMPING

Kode Barang : BR 39100 (38MM) GALV
Kode Komputer : 1601539001



BREKET GANTUNG

Kode Barang : BR 39185 (38MM) GALV
Kode Komputer : 1601539181

INDEKS AKSESORIS PINTU DORONG

(untuk ukuran 60 Kg)



DOUBLE CYLINDER

Kode Barang : CYL DC DL 60MM SN
Kode Komputer : 301211601



GRENDEL ATAS

Kode Barang : BB 8104-UK 75CM
(38/57MM) GALV
Kode Komputer : 11601581041



GRENDEL BAWAH BIASA

Kode Barang : BB 9204 (38/57MM)
GALV
Kode Komputer : 1601592041



GRENDEL BAWAH BERODA

Kode Barang : BB 8204 (38/57MM)
GALV
Kode Komputer : 1601582041



REL ATAS

Kode Barang : TR 39123 - 2.3M
(38 MM) GALV
Kode Komputer : 1601539121
Kode Barang : TR 39129 - 2.9M
(38 MM) GALV
Kode Komputer : 1601539191



REL BAWAH

Kode Barang : TR 9224 - 2.4M
(38/57 MM) GALV
Kode Komputer : 1601592241
Kode Barang : TR 9230 - 3M
(38/57MM) GALV
Kode Komputer : 161592301

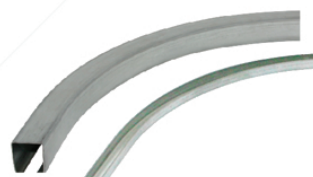

REL TIKUNG ATAS & BAWAH

Kode Barang : TR 39190 R60 (38 MM) GALV
Kode Komputer : 1601539601



GRENDEL TANAM PLAT

Kode Barang : FBP 8" SSS
Kode Komputer : 1701054501



MORTISE ROLLER

Kode Barang : MTS RL DL 8585 SSS
Kode Komputer : 201121521



ENGSEL KUPU-KUPU

Kode Barang : ES EL 4x3x3MM 2BB SSS
Kode Komputer : 101131321



MORTISE SLIDING

Kode Barang : MTS SLD DL 84100 N
Kode Komputer : 201121521



PULL HANDLE DEKSON

Kode Barang : PH D855
19x195x152 SSS
Kode Komputer : 801180051



ESCUTCHEON

Kode Barang : ESCN 855 SSS
Kode Komputer : 901108551



BAUT BREKET & FISHER

Kode Barang : BF 3/8x2.5" (38/57 MM) GALV
Kode Komputer : 1601538251
Kode Barang : BF 3/8x3" (38/57 MM) GALV
Kode Komputer : 1601538351
Kode Barang : BF 3/8x4" (38/57 MM) GALV
Kode Komputer : 1601538451



AVAILABLE AT :

